

TECHNICAL AND OPERATING DOCUMENTATION

ASSEMBLY INSTRUCTIONS,
OPERATION AND SAFE USE

(original instructions)

5 Steel and aluminium components and assemblies

5.10. LED Pergola Lighting Kit SB400 /SB400PRO/ SB500

PRODUCT NAME:

LED PERGOLA LIGHT KIT
SB400/SB400PRO/SB500

THE PRODUCT MANUFACTURER'S DESIGNATION:

- Manufacturer's name: SELT Ltd.
KRS 0000589791, share capital: PLN 64,000,000
NIP: 7543103311, REGON: 363154414, BDO No. 000009177
- Headquarters of the manufacturer:
45- 449 Opole, ul. Wschodnia 23A
- Contact details: Tel:
+48 534 598 065
- Website:
www.selt.com
- E-mail address:
kontakt@selt.com

PRODUCT SAFETY MARKING:

The product meets CE safety requirements.

THIS TECHNICAL AND OPERATIONAL DOCUMENTATION:

- is valid from: 01 June 2023.
- applies to the product versions marked above

TABLE OF CONTENTS

1	Introduction	4
1.1	Product safety notes	4
1.2	Explanation of symbols and marks.....	4
1.3	Terms and definitions.....	5
1.4	Subject matter, purpose and content of the dossier	5
2	Technical product information.....	6
2.1	Technical parameters	6
2.2	Product features.....	11
3	Transport and storage of goods.....	12
3.1	Completeness and quality condition of the delivery.....	12
3.2	General conditions for transport and storage of the product.....	12
3.3	Descriptions that must obligatorily appear on the product packaging	12
4	Assembly of the product	13
4.1	General requirements for safe installation.....	13
4.2	Requirements for the safe installation of the product at height.....	13
4.3	Preparation for assembly	13
4.4	General product installation guidelines	13
4.5	Assembly tools	14
4.6	Assembly	16
4.6.1	LED strip.....	16
4.6.2	LED points in the pens.....	19
4.7	Electricity supply.....	20
4.7.1	connection to the electrical system.....	20
4.7.2	Commissioning and adjustment	22
5	System operation and product safety	22
5.1	General health and safety requirements	22
5.2	Safety requirements related to the specific conditions and places of use of the product	22
5.3	Safety in handling.....	23
5.4	Control.....	24
5.5	Commissioning and adjustment.....	24
5.6	Misuse of the system.....	24
6	Operation and maintenance of the system.....	26
6.1	Intended use of the system	26
6.2	Instructions for non-experts.....	26
6.3	Indications of risk, accident or incident.....	26
6.4	Maintenance and repairs	27
7	Complaint/technical defects.....	28
7.1	Complaints (manufacturer's warranty).....	28
7.2	Technical defects.....	28
8	Dismantling / disposal / decommissioning of the product.....	28
9	CE marking and labelling of the product	29
9.1	CE conformity of the product.....	29
10	Exclusions from liability.....	30
10.1	Exclusions from liability.....	30

1 INTRODUCTION

1.1 PRODUCT SAFETY GUIDELINES.



The product has been manufactured in accordance with the latest technical knowledge in design and manufacturing technology and meets the safety requirements in accordance with the following standards.



Lp.	Subject	European legal basis	Polish Legal Basis
1	Essential requirements for machinery	Directive 2006/42/EC of the European Parliament and of the Council	Regulation of the Minister of Economy of 21.10.2008 on essential requirements for machinery (Journal of Laws 2008 No. 199 item 1228) with as amended (OJ 2011.124)
2	Electromagnetic compatibility (EMC) directive	Directive 2014/30/EU of the European Parliament and of the Council	Act of 13.04.2007 on electromagnetic compatibility (i.e. Journal of Laws 2019, item 2388) Act of 13.06.2019 on the system of conformity assessment and market surveillance (Journal of Laws 2019 item 544) as amended (Journal of Laws. 2020 pos.1086)
3	Low Voltage Directive (LVD)	Directive 2014/35/EU of the European Parliament and of the Council	Regulation of the Minister of Development of 2.06.2016 on the requirements for the electrical equipment (i.e. Journal of Laws 2016, item 806) Act of 13.06.2019 on the system of conformity assessment and market surveillance (Journal of Laws 2019 item 544) as amended (Journal of Laws. 2020 pos.1086)
4	LED modules for general lighting purposes. Requirements safety.	EN 62031:2008+A1:2013 +A2:2015	PN-EN 62031:2010/A2:2015-04
5	Photobiological safety lamps and lamp systems	EN 62471:2008	PN-EN 62471:2010

Related documents: Declarations of Conformity for the LED strip and the power supply and installation instructions for the power supply and control.

1.2 EXPLANATION OF SYMBOLS AND SIGNS

The following symbols (pictograms) indicate particularly important hazard and safety information.

Pictogram	Meaning of the pictogram	Information
	INFORMATION	Read the operating instructions before using the product. Compliance with the operating instructions is a prerequisite: - failure-free operation of the product, - intended use, - to preserve entitlements, e.g. under warranty. For the safety of persons, keep the instructions.
	INFORMATION	No harmful or hazardous consequences for people or objects.
	NOTE!	Situation likely to cause damage to the product or requiring action by the user. No risk to humans.

	DANGER!	This symbol indicates all safety information, the non-observance of which poses a risk to life or health of persons. Risk to health or life. Risk: danger of serious injury or death. Dangerous operation likely to cause injury or damage product.
	WARNING!	Risk to health or life through electric shock.
	ENVIRONMENT	Marking of electrical or electronic equipment subject to collection at designated points.

1.3 TERMS AND DEFINITIONS

The terms and definitions used in this documentation mean:

Product: LED lighting kit

It is designed for SB400 or SB400PRO or SB500 pergolas as a set of components enabling the implementation of perimeter lighting with LED strips and/or LED points on selected pergola blades.

Includes: 240V/24V power supply, power supply bracket, controller with remote control, power cables, LED tape, tape-to-tape compression connectors, tape-to-cable compression connectors, 3M quick connectors (for cable pairing), LED troughs, LED aluminium profiles, LED milk cap.

Depending on the order, installation is possible: to a product without lighting and to a product with LED lighting installed. LED guttering includes a recess for lighting. Profiles for LED strip painted from the outside in the colour of the pergola. LED light curtains offered in continuous lengths with a margin for trimming by the customer.

LED spotlights include complete pens with attached light points including wiring and a collective cable located in the drive beam (SB400/500 versions) with protruding plugs in the holes for seating the pens.

PERFORMANCE VERSIONS:

Product without LED strip - LED kit for self-assembly. Includes separate LED strips cut to the dimensions of the product and drilled, screws, LED milk covers in segments matching the sides of the pergola (with spare), power supply unit, LED tape, power supply holder, connectors and cables, controller with remote control, milled gutter plugs.

Product with LED strips installed - LED kit to be completed during installation. Includes LED gutters, separate LED strips drilled) and cut to the dimensions of the product (2 gutter version only), screws, LED milk covers in segments to match the sides of the pergola (with spare), power supply unit, LED gutter cap with milled groove for cables, connectors and cables. The power supply bracket is already tightened inside the selected pole (SB400/500) or loose (SB400PRO).

Product with LED points in the blades - a set of 2 to 4 blades (depending on the overhang) with attached LED points (2 to 3 - depending on the width) and an outgoing cable plug, as well as a collective cable: mounted in the drive beam with outgoing plugs for the LED blades (for SB400/SB500) or a bearing beam with windows in the upper chamber (under the revision) with a separate collective cable (for SB400PRO).

1.4 SUBJECT MATTER, PURPOSE AND CONTENT OF THE DOSSIER

The products manufactured by **SELT Sp. z o.o.** are the subject of this documentation.

The documentation applies to the LED lighting kit for the product types: **PERGOLA SB400, PERGOLA SB400PRO, PERGOLA SB500.**



The instructions for use and safe operation must be handed over to the end user.

IMPORTANT SAFETY INSTRUCTIONS
WARNING - FOLLOWING THESE INSTRUCTIONS IS IMPORTANT FOR THE SAFETY
OF PERSONS
KEEP THIS INSTRUCTION

The documentation is part of the delivery of the product and should be kept close to it at all times.

The documentation includes:

- important recommendations for the installation, use and maintenance of the product,
- important recommendations for transport and storage,
- guidelines to be followed for the operation of the product.

SELT Sp. z o.o. shall not be liable for damage resulting from failure to observe the recommendations contained in this documentation.

In order to further improve the product, SELT Sp. z o.o. reserves the right to make changes which, while maintaining the essential technical parameters, are deemed advisable in order to increase the product's quality of service and safety of use.

The copyright for this documentation remains with SELT Sp. z o.o. in Opole. Without the permission of SELT Sp. z o.o., the documentation may not be used in any way, either in whole or in part.

2 TECHNICAL PRODUCT INFORMATION

The technical product specification is available by logging on to www.selt.com.

2.1 TECHNICAL PAREMETRES:

LED lighting kit - Pergola SB400

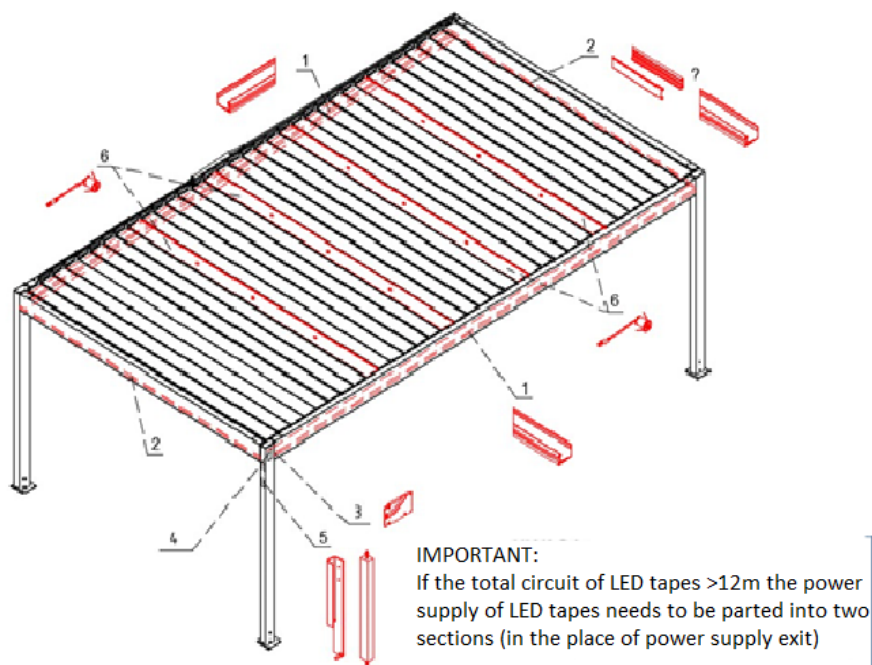

Longitudinal beam

Latitudal beam (4 gutters)

Latitudal beam (2 gutters)
LED Stripe is packed separately

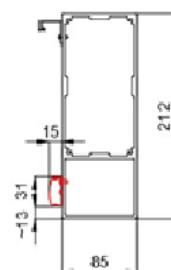
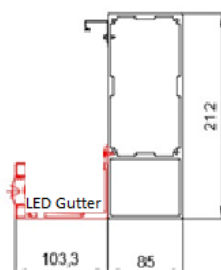
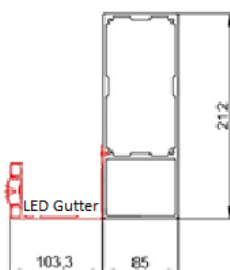
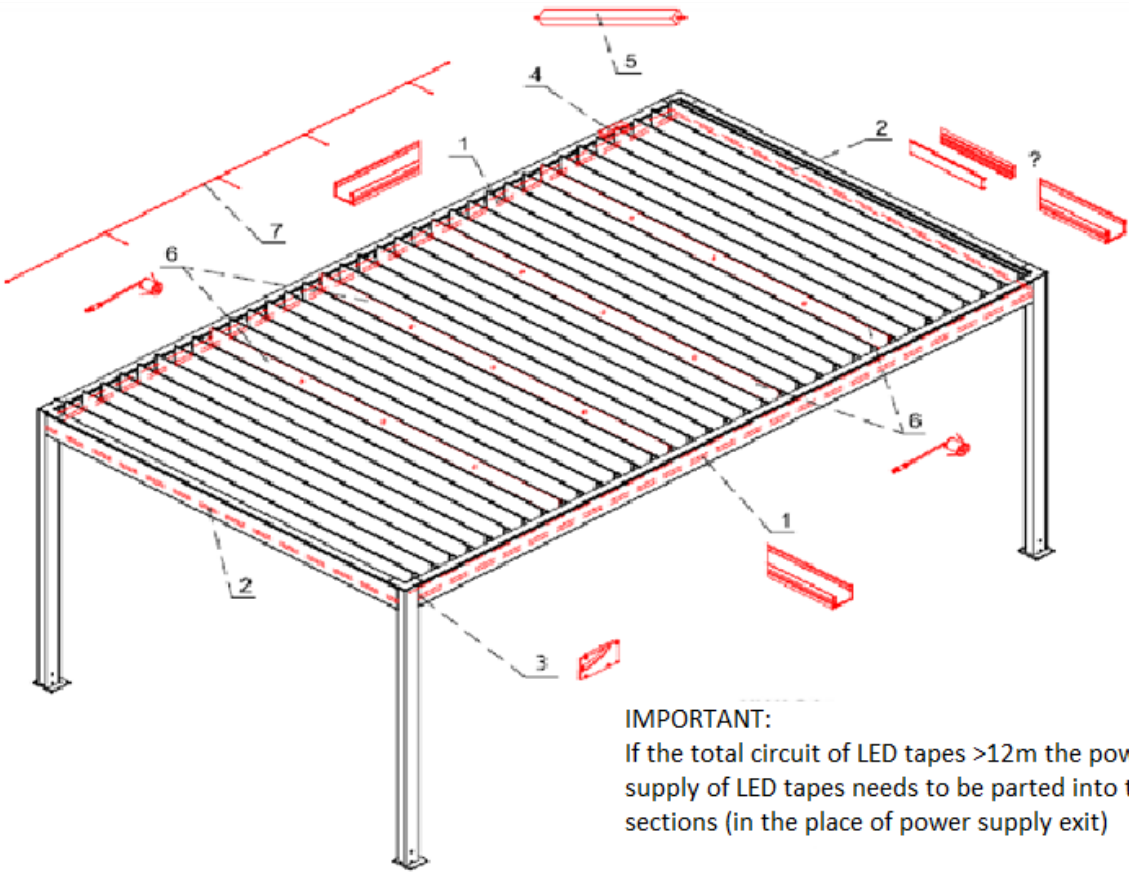

Fig. 1 Lighting kit in pergola SB400 - location marked in red.

(1-LED gutter with LED strip; 2- LED strip (when 2 gutters) or LED gutter (when 4 gutters); 3- LED gutter caps; 4- lighting controller; 5- power supply with bracket, 6- pen with light points)



Longitudinal beam

Latitudal beam (4 gutters)

Latitudal beam (2 gutters)
LED Stripe is packed separately

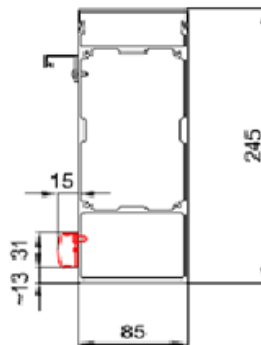
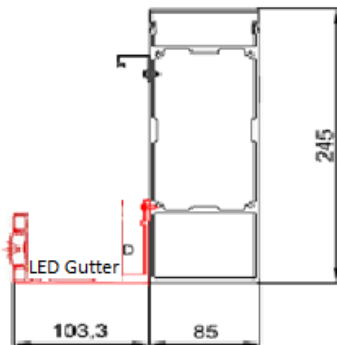
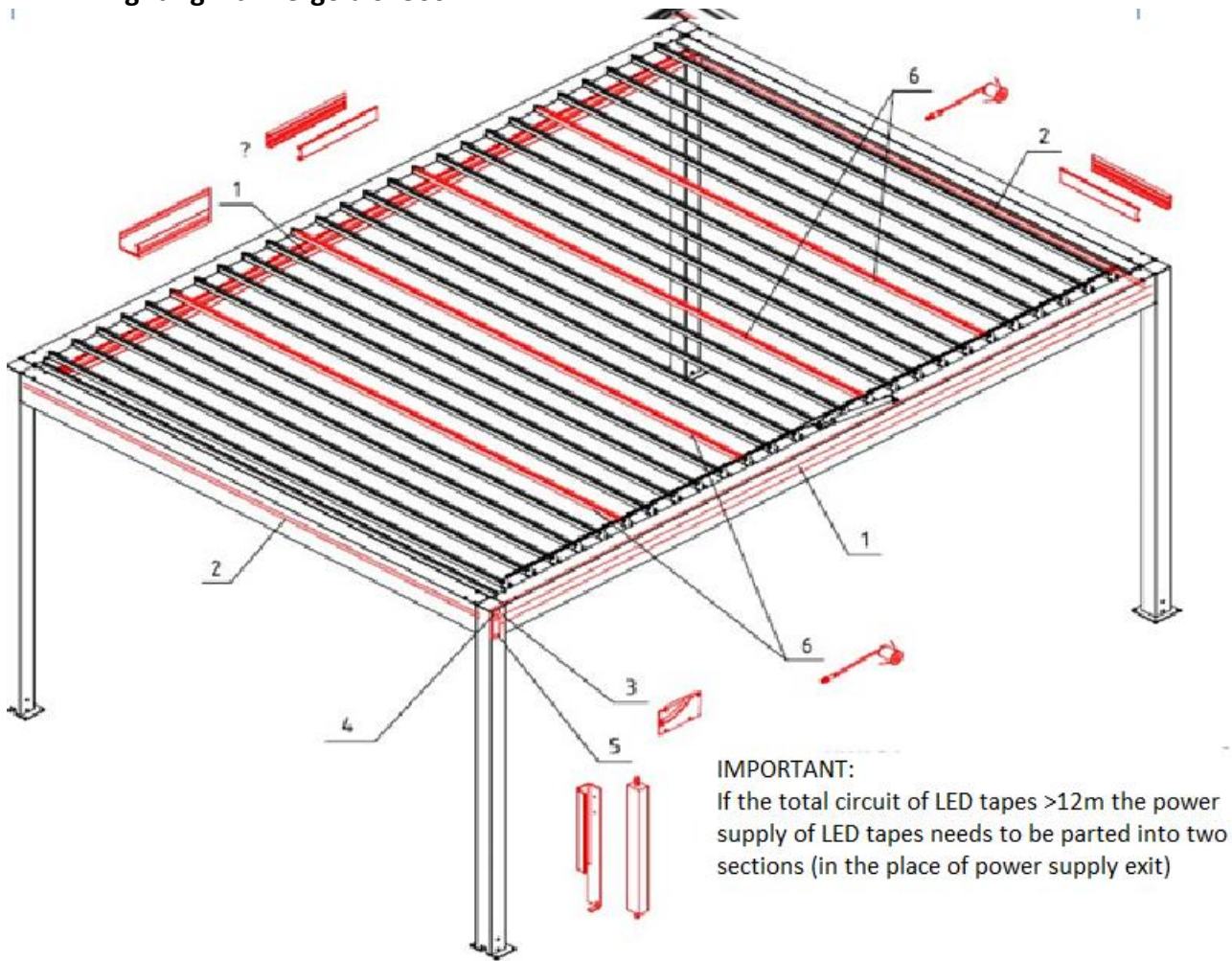

Fig. 1A. Lighting kit in pergola SB400PRO - location marked in red.
 (1 -LED gutter with LED strip; 2- LED bar (when 2 gutters) or LED gutter (when 4 gutters); 3- LED gutter plugs; 4- lighting controller (White LED Receiver); 5- 24VDC power supply, 6- pen with light points; 7- cable to bar+at opposite ends: plug and power cable)

LED lighting kit - Pergola SB500



Latitudal beam
(2 gutters)

Every beam (4 gutters)
(LED Stripe is packed separately)

Latitudal beam (2 gutters)
LED Stripe is packed separately

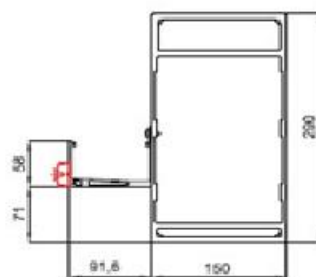
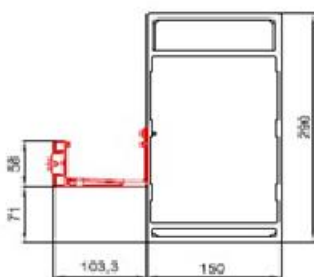

Fig. 2. Lighting kit in SB500 pergola - location marked in red.
(1-LED gutter with LED strip (when 2 gutters); 2- LED strip (when 4 gutters); 3- LED gutter caps; 4- lighting controller; 5- power supply with bracket, 6- pen with LED points)

Technical specifications of the LED strip lighting kit	
Maximum length of LED from a single power point	12 m
Gutter height / LED bar	58/31 mm
Width of gutter/LED strip	103/ 10 mm (profiles); 108/15 mm (with cover)
Parameters of the LED strip:	
- power supply	24 V DC
- power	6 W / mb
- diodes	SMD2835 - 60 LED / mb
- clarity	295.8 lm/ 0.5 mb
- colour of light	4000 K (neutral white)
- colour rendering index CRI	Ra=80
- light angle	120 °
- current consumption	121 mA/0.5 m
- degree of protection	IP 65
- strap length / cut-off	12 mb / every 10 cm
- LED strip width	8 mm
- operating temperature	-25°C to +60°C
Technical specifications of the lighting set LED points in the pens	
Number of points in the pen	2 to 3 (width-dependent)
Number of pens with LED points	2 to 4 (depending on overhang)
LED point parameters:	
- power supply	24 V DC
- outer diameter of the luminaire	25 mm
- reflector diameter	13 mm
- colour of the luminaire	Anodised aluminium
- point power	3,1 W
- current consumption per point	0,125 A
- clarity	215 lm
- colour of light	3300 K (warm white)
- light angle	60 °

- current and power consumption	0,125 A
- degree of protection	IP 54
- housing temperature	to +45°C
Power supply parameters:	
- dimensions	315x30x23 mm
- supply voltage	240V/50-60Hz; <1 A
- power	150 W
- Output current max.	6,25 A
- degree of protection	IP 66
- output voltage	24V DC +/-5%
- operating temperature	-20°C to +45°C
Assembly:	
On-site assembly	In an aluminium bracket inside the pergola post (SB400/500) or in the upper chamber of the beam under the revision (in SB400PRO)

Detailed data on the performance of the controllers is available on the manufacturers' websites and on the website:

www.selt.com → OUR OFFER → AUTOMATION

Layout of LED dots in SB400 and SB400PRO pergola pens				
Overhang of the pergola [mm]	Total number of blades with LED spots	Pen No. with LED spots on <u>the front of the pergola</u>	Number of LED points in the pen	
			Width of pergola [mm]	
			up to 2750	2751 to 4000
1400	2	2, 5	2	3
1600 i 1800		3, 6		
2000 i 2200		3, 7		
2400		4, 8		
2600 i 2800		4, 9		
3000		5, 10		
3200 i 3400		5, 11		
3600	3	4, 9, 14		
3800		5, 10, 15		
4000 i 4200		4, 10, 16		
4400 i 4600		5, 11, 17		
4800 i 5000		6, 12, 18		
5200	7, 13, 19			
5400	4	4, 10, 16, 22		
5600 i 5800		5, 11, 17, 23		
6000 i 6200		6, 12, 18, 24		
6400 i 6600		7, 13, 19, 25		
6800 i 7000		8, 14, 20, 26		

Arrangement of LED dots in the SB500 pergola blades				
Overhang of the pergola [mm]	Total number of blades with LED spots	Pen No. with LED spots on the front of the pergola	Number of LED points in the pen	
			Width of pergola [mm]	
			2000 to 3500	3501 to 5000
2000	2	1, 5	2	3
2250		1, 6		
2500		3, 6		
2750		3, 7		
3000		4, 7		
3250		4, 8		
3500 i 3750		4, 9		
4000		5, 10		
4250 i 4500		3		
4750 i 5000	5, 9, 13			
5250	4	3, 8, 12, 16		
5500		3, 8, 12, 16		
5750		3, 8, 13, 18		
6000 i 6250		4, 9, 14, 19		
6500 i 6750		5, 10, 15, 20		
7000		6, 11, 16, 21		

2.2 PRODUCT CHARACTERISTICS

They are characterised by the following features:

- LED strip with high IP64 protection rating
- LED gutters have an integrated compartment for LED tape
- Extruded strip for the band painted in the same colour as the structure and flush with the underside of the gutters
- Tape colour - neutral white
- Light points in aluminium housing
- Applause points - warm white
- Power supply and control module concealed inside the pergola post (SB400/400PRO) or in the upper chamber of the beam under the revision (SB400PRO)
- Easy connection of LED strip sections with dedicated connectors
- Groove in LED gutter cap for passage of cables from LED gutter/leaf from power supply in pole
- The pergola perimeter, which is more than 12 mb long, is fed bilaterally
- Blades armed with points with easy plug-in connection
- Power supply with high IP66 protection rating
- LED cable separately (in SB400PRO)

3 TRANSPORT AND STORAGE OF GOODS

3.1 THE COMPLETENESS AND QUALITY CONDITION OF THE DELIVERY

The goods of SELT Sp. z o.o. are in accordance with their production technology. In the case of any reservations concerning the product or damage to its packaging, such reservations or remarks should be notified to the driver / warehouseman / assembly team and marked on the WZ document under pain of losing any claims on this account, and a protocol describing such reservations or remarks should be drawn up with the participation of the driver.

At acceptance, mechanical defects, scratches, cracks, etc., as well as quantitative objections must be reported in particular, under penalty of being deemed not to exist. Hidden defects must be reported in accordance with the warranty or guarantee conditions.

3.2 GENERAL CONDITIONS FOR TRANSPORT AND STORAGE OF THE PRODUCT

List:

- The product is p r e - p a c k e d in a cardboard box, which protects it from damage during storage, during transport and during its movement to the final installation site,
- the products to be transported/stored should be positioned in accordance with the arrows on the product packaging,
- products should not be stored in more than 2 layers due to the possibility of crushing the packaging, which may result in permanent damage to the product,
- do not load the product packaging with other objects,
- products placed on the means of transport must be secured against displacement and damage during transport (e.g. spacers, safety belts, etc.),
- during transport the products must be protected from rain or snow,
- storage areas should be dry, ventilated and protected from the harmful effects of the weather (sun, rain, etc.),
- if the weight of the product exceeds 25 kg, its transport to the place of final assembly must be carried out by at least two persons (depending on the weight of the ordered product).

3.3 DESCRIPTIONS WHICH MUST MANDATORILY APPEAR ON THE PRODUCT PACKAGING.



Before installing and using the product, carefully read the technical and user documentation available at <http://www.selt.com/dte-pl>.

4 ASSEMBLING THE PRODUCT

This chapter contains the general requirements for the installation of the product. Correct installation is a prerequisite for the smooth functioning of the product. SELT Sp. z o.o. recommends the use of specialised installation teams to guarantee the correct installation to the Purchaser.

4.1 GENERAL REQUIREMENTS FOR SAFE INSTALLATION

- the rules of the trade must be observed,
- the applicable health and safety regulations must be complied with, particularly with regard to the safety of working with electrical equipment and working at heights,
- the product must be fixed mechanically; foams, adhesives or similar materials must be used in accordance with the recommendations of their manufacturers, taking into account the specific nature of the product,
- prior to installation, all unnecessary objects should be removed from the installation area, and the installation site should be marked and appropriate safeguards applied to protect people.

4.2 REQUIREMENTS FOR SAFE INSTALLATION OF THE PRODUCT AT HEIGHT



The installation of the product is particularly dangerous as it involves work at heights and poses a particularly high risk to human health and safety, in particular falls from heights.

It is the responsibility of the installer (hereinafter referred to as the Installer) or the party commissioning such work (hereinafter referred to as the Investor) to ensure that a health and safety plan is drawn up during installation. The developer/installer should specify specific health and safety requirements when carrying out work at height, and in particular ensure:

- direct supervision of their execution by persons designated for this purpose (e.g. works manager, foreman),
- appropriate safety measures, primarily fall protection equipment,
- detailed instruction of workers performing work at height.

Work at a height of more than 2 m where personal protective equipment against falls from height is required must be carried out by at least 2 persons.

Work at height should be organised and carried out in a way that does not force workers to lean beyond the handrail of the railing or the outline of the device on which they are standing. It is not permitted to stand on parts of the product.

The Installer/Installer must ensure that only authorised and appropriately trained and informed persons have access to sites where works at height are being carried out. The Investor/Installer shall inform of the works at height being carried out and of the necessary safety measures to be observed during such works by persons present or likely to be present in or adjacent to the area where such works are being carried out.

4.3 PREPARATION FOR ASSEMBLY

- unpack the product and check that all the components necessary for its installation are present,
- before installation, check that the substrate/substructure has sufficient load-bearing capacity for safe installation and operation.

4.4 GENERAL PRODUCT ASSEMBLY GUIDELINES

- Incorrect installation or errors during installation and connection to the electrical system can have serious consequences on the operation of the product,
- check that the installation space is clear of obstructions before proceeding with the installation,
- protect the product from soiling (e.g. mortar, installation foam, silicone) which may cause damage,
- trim the LED strip by hand.



Incorrect installation and connection can contribute to dangerous situations for the user.

4.5 ASSEMBLY TOOLS

Instructions for assembly, operation and safe use after logging in are available at www.selt.com.

List:









- metal drill bits,
- screwdriver,
- ladder,
- screwdriver,
- measure,
- pencil/writer,
- spirit level,
- pin spanners (Allen keys),
- flathead screwdriver,
- pliers,
- wallpaper cutter.

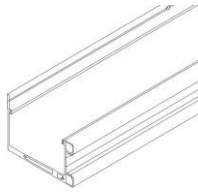
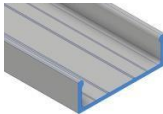



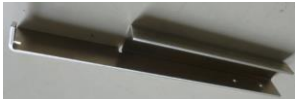

Attention:

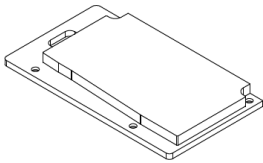

- Verify the visual condition of the packaging of the components before assembly delivered for assembly, the visual condition of the components and their completeness. Damage caused in transit is the responsibility of the carrier.
- The components are supplied packaged and covered in stretch fabric for protection during assembly.
- Accessories are packaged in cardboard boxes.

List of elements:

LED gutter 103x75 mm		Aluminium strip 33x10 mm	
LED strip (rolls L= 12 mb)		Milky blende (sections like gutters or slats)	
LED strip connector (when LED strip L<12m)		Tape-and- cable connector	
Insulated copper cables		Power supply	
Power supply bracket (not SB400PRO version)		3M connector	

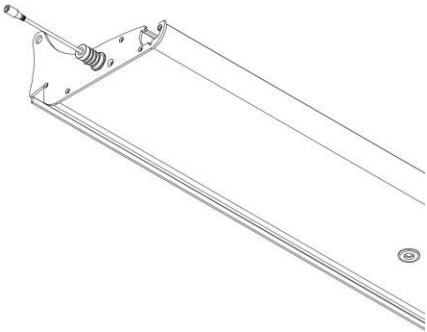
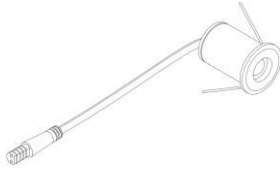
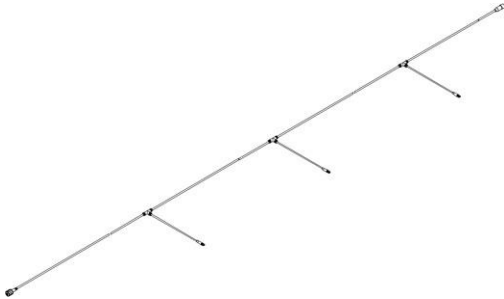
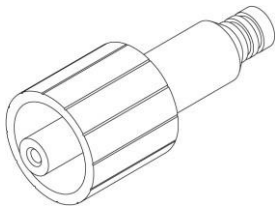
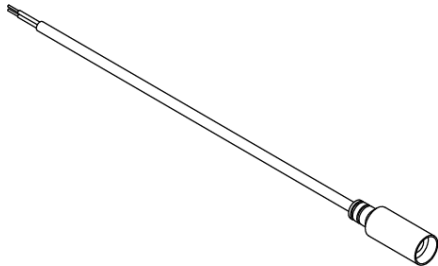
<p>LED gutter cap (milled)</p>		<p>Remote control for the controller Mi-Light</p>	
<p>Mi-Light controller</p>		<p>Pilot IO (alternative)</p>	
<p>IO controller (alternative)</p>		<p>Screws St 4.8x13</p>	
<p>Blades with light points and cabling</p>		<p>2 to 4 pcs (dependent on the overhang of the pergola)</p>	
<p>Collecting cable for LED pens to the bar (bulk for SB400PRO or fitted in the beam for SB400/500)</p>		<p>Stopper (attached to the end of the collective cable for LED pens)</p>	
<p>Power cable (attached to the end of the collective cable for LED pens)</p>			

4.6 MOUNTING

4.6.1 LED TAPE

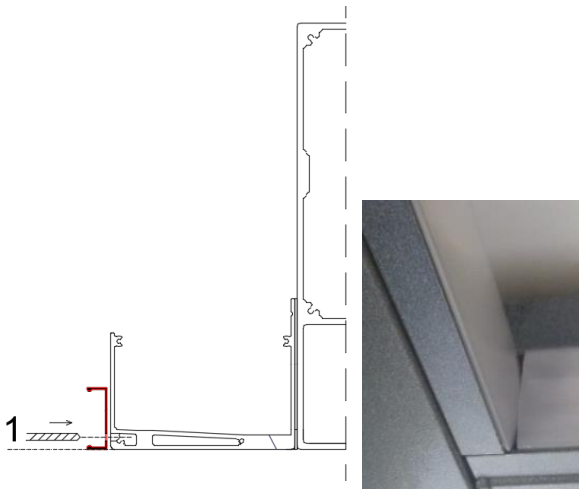

1. Arrange all LED gutters (system with 4 gutters) and/or LED strip elements on the correct sides of the pergola. The LED gutters or LED strips connect to each other at right angles overlapping each other (Fig. 1).
2. Place the LED strips between the LED gutters flush with the underside of the LED strip or the underside of the gutters (for gutters without LED chamber). Drill holes in the gutter with a $\varnothing 4.2$ drill according to the hole pattern of the strip (fig. 1).

Figure 1

NOTE1: Careless drilling of the holes in the LED strips attached to the gutters can lead to unsealing of the lower gutter wall. When drilling, do not damage the paint finish on the edge of the aluminium slats.

NOTE2: For systems with two LED gutters, these are factory-tightened to the longitudinal beams - attach the LED strips to the cross beams.

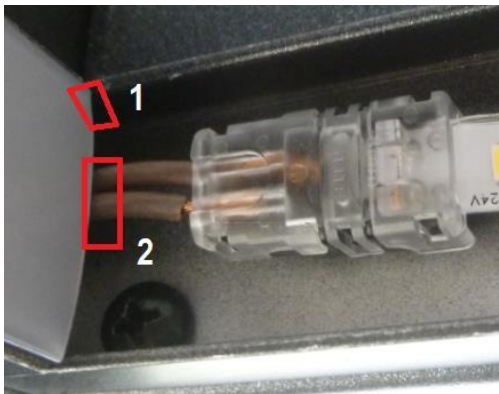

The LED gutter end caps have a cut-out and a groove for cables at the point where the cables for the LED strip feed out. Make a localised cut-out in the LED strip for the cable outlet - fig.2 (in case of a fitted gutter cover with groove for cables - cut-out in the rear wall - area "2"; otherwise cut-out in the upper wall - area "1").

Figure 2

NOTE: With a total LED strip length >12 m, the power supply is double-sided (4 cables will come out of the corner). Make the holes correspondingly larger.

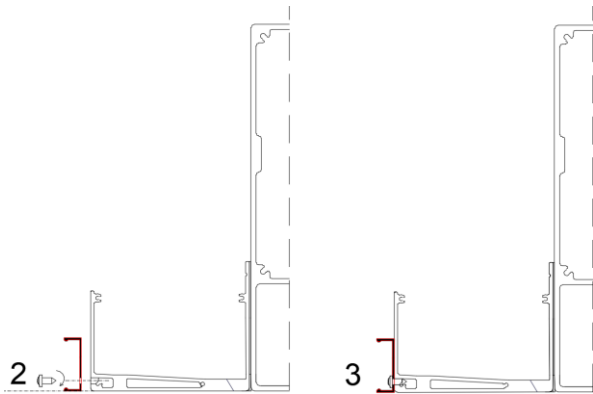

4. For gutters without LEDs, screw the LED aluminium strips with St4.8 screws into the gutter (fig.3). Note the position of the notch for cable exit.
5. Apply the LED strips to the cross beams (or gutters on these beams), facing the underside of the LED gutter. Repeat installation steps 2 and 4.

Figure 3

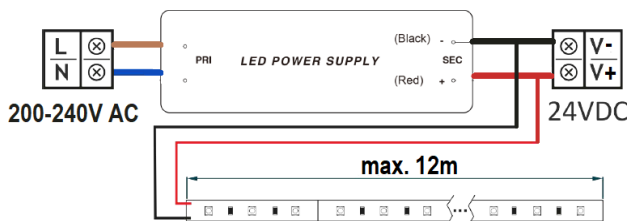

6. When the total length of the LED strip around the perimeter of the pergola ≤ 12 mb power supply is from one end of the belt (Fig. 4)

Figure 4

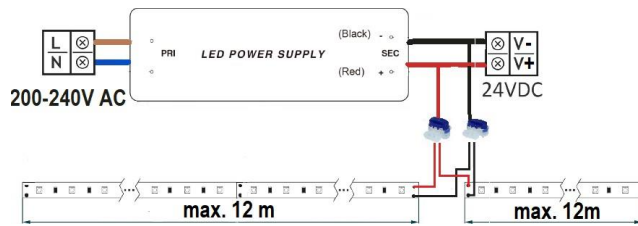

7 When the total length of the LED strip on the perimeter of the pergola is > 12 mb the power supply should be divided into 2 sections from a common corner (at the pole with the power supply) (fig. 5).

Figure 5



8. Fit cable connectors with embedded cables onto the ends of the LED strip with power connection. (fig. 6 - left). Insert the cables into the groove in the gutter cap - fig. 6 - right (version prepared for LED) or lay them at the edge of the gutter cap (version without LED). Above the gutters in the post, make a convenient hole for the cable entry into the post.

Figure 6

Use 3M airtight connectors (Fig. 7) to connect double cables from LED strips. Fix them inside the pole. Connect the cables with the same pole. The tape can be cut at the points marked with scissors (sections every 10 cm)- fig. 7 (bottom left). Joining the LED strip sections together is possible with the strip connectors (fig.7 - bottom right)

Figure 7

NOTE: Pay attention to polarity compatibility in connections.

10. apply the LED strip in the corner from the cable connector side and glue it in the middle to the groove in the LED trough or LED strip (Fig. 8).

Figure 8

NOTE: When gluing the LED strip, take care to degrease the structure and to tension the strip evenly and straightly to avoid waving the luminous LED line.



The position of the power cable connector causes a dead spot in the corner (fig. 9). The phenomenon can be minimised by pushing the cable connector as close as possible to the corner.

Figure 9



12. measure, cut and fit the covers (blends) to the LED gutter or aluminium strip (fig. 10). The blender is supplied in sections equal to the LED gutter or strip with a small allowance. It must be cut to size on the object.

Figure 10

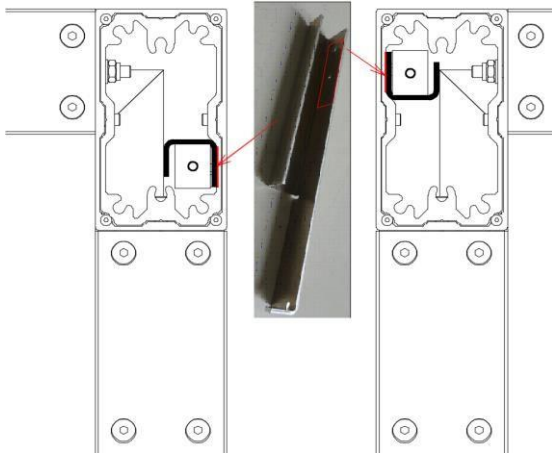

13. Unscrew the cap at the top of the pole with the planned power supply.
14. Inside the selected pole, fasten the PSU holder by positioning it as shown in Fig. 11 - with the extended arm with the bend pointing downwards (Fig. 12). To do this, glue a section of double-sided construction tape (red line - see arrow - fig. 11) on the wall of the holder with the double holes, after degreasing it. Degrease the gluing area inside the insert in the post. The top edge of the holder is approx. 4.5 cm below the top of the post (fig. 12).

Figure 11



NOTE: In the LED version, the power supply bracket is screwed inside the pole (fig. 12).
For the SB400PRO, the power supply bracket is not used, but is placed in the top compartment of the bar under the revision.

Figure 12



15. connect the output cables from the LED strip inserted into the pole to the driver (fig.13). Pay attention to leave a reserve of cables in order to place the driver over the power supply and to connect them correctly according to the markings on the driver.

Fig. 13

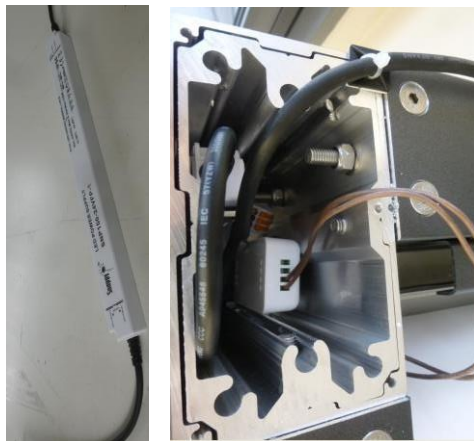

16. connect the power supply to the controller. Then insert into the hanger in the pole and place the controller above or beside it (fig. 14). Lead the power cable out through the top cap of the pole or lead it into the selected corner of the pergola with the beam profile using the installation holes fi 20 made in the connectors (fig. 15).

Figure 14



Figure 15



Run the cable through the hole made in the cap (inserting the choke), insert the plug and connect the system to the power supply - see conditions in point 4.7. Perform a lighting operation test (fig. 16).

Figure 16

4.6.2 LED POINTS IN PENS

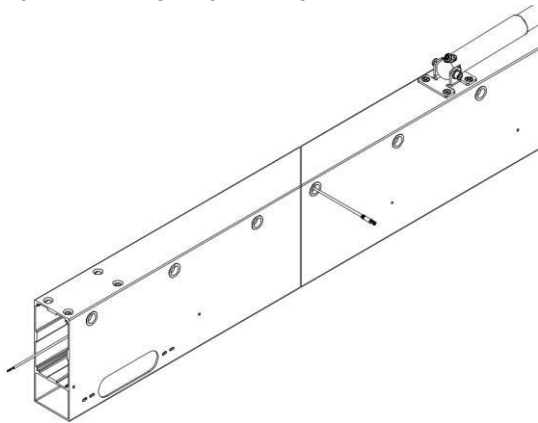

- 1 For the SB400/500 pergolas, cables terminated with plugs in the fixed holes of the blade pins are brought out from the factory in the longitudinal drive beam (fig. 16A). The collective cable is brought out at the end of the beam (towards which the motor power supply is directed). The two-wire collective cable has the power cable already tightened and is terminated with soldered ends.

Figure 16A

NOTE: The bulk cable at the opposite end has a plug fitted, which is required to close the electrical circuit.

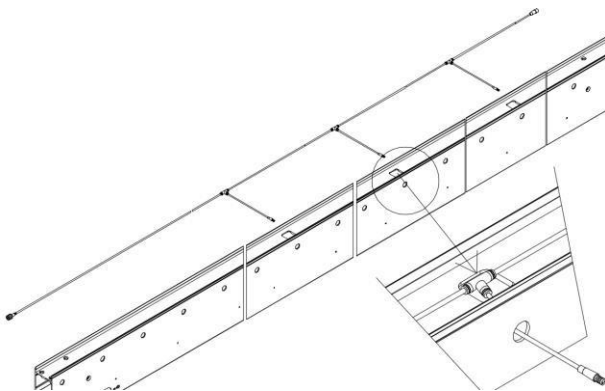

2. For the SB400PRO pergola, oval 40x40 mm windows were made in the longitudinal bearing beam in the upper chamber under the revision at the LED pen locations (Figure 16B).
3. The separately issued bulk cable feeding the LED points should be laid in the upper compartment (under the revision), inserting the cable legs for the LED pens by sliding into the upper window and pulling the plugs from the side of the beam through the pen pin hole.

Figure 16B

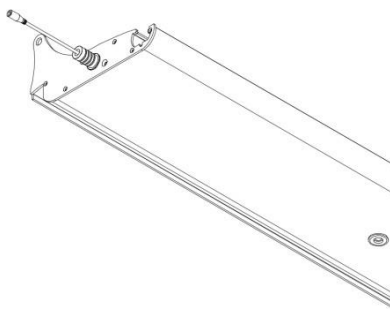

- 4 For pergolas SB400/500, LED points have been pre-installed in the quills with LED lighting and a cable has been routed in the quill pin on the drive cap side (fig.17A).

Figure 17A

NOTE: The bulk cable inside the pen at the opposite end from the lead has a plug fitted, which is required to closing the electrical circuit.

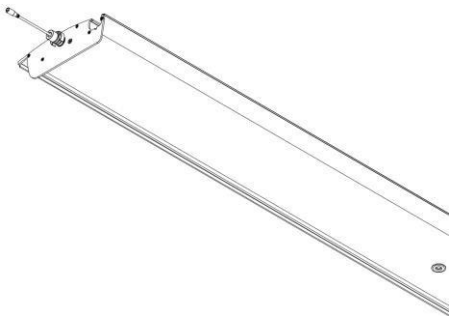

- for the SB400PRO pergola, LED points have been pre-installed in the quills with LED lighting and a cable has been routed in the quill pin on the bearing cap side (fig.17B).

Figure 17B

NOTE: The bulk cable inside the pen at the opposite end from the lead has a plug fitted, which is required to close the electrical circuit.

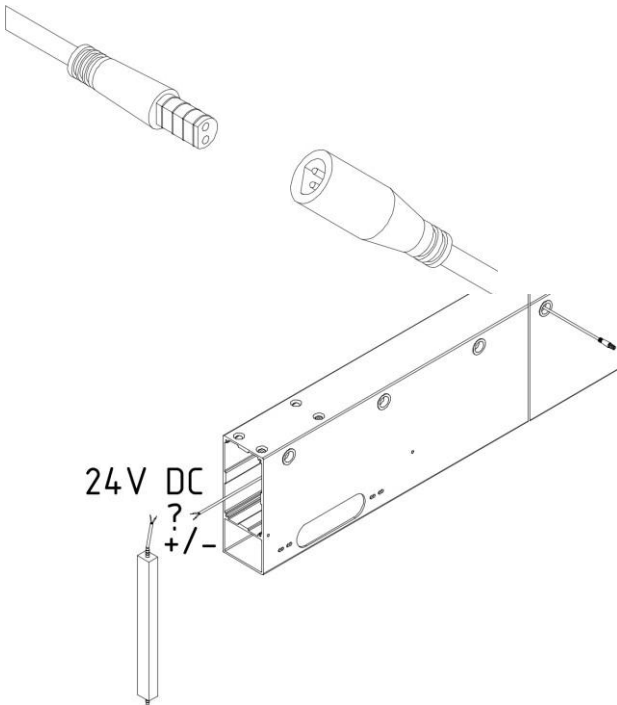

- For SB400/500 pergolas, remove the foil protecting the cables from sliding into the beam before installation.
- For the SB400PRO pergolas, the collective cable should be arranged according to point 3. Connect the plug from the beam to the plug in the pen pin (fig.18) until fully pushed in. Then slide the connected plugs (backwards) inside the beam.

Figure 18

- Using a 24V DC power supply, check the polarity of the soldered ends of the bulk cable at the end of the beam (fig.19) and mark for correct connection.

NOTE: Swapping the poles does not damage the LED dots in the pens, only the lack of illumination of the dots.

Figure 19

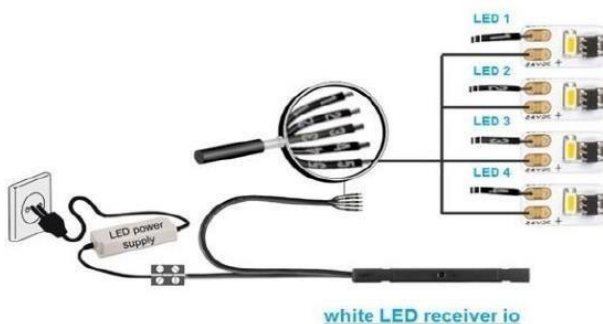

- connection to the White Led Receiver controller perform in accordance with the controller's instructions.

ATTENTION: It is not permissible to connect all lighting cables with a "-" pole to only one output due to the risk of damaging the controller (exceeding the output load). Cables with pole "+" is connected together to output 5 from the controller (fig. 20).

Figure 20

4.7 ELECTRICAL SUPPLY

4.7.1 CONNECTION TO THE ELECTRICAL SYSTEM

Once the lighting system has been installed, it should be connected to the previously prepared installation: the power supply. The connection to the electrical supply system must be carried out on the basis of an individually prepared wiring diagram (by qualified persons) taking into account the principles of electric shock protection. The connection must be made by an electrician with current electrical qualifications.

Make the electrical connection in accordance with the instructions of the manufacturers of the power supply, driver and LED strip. The instructions are enclosed with the product and are also available on the manufacturers' websites:

www.selt.com → OUR OFFER → AUTOMATION

Connect the LEDs depending on the type of controller according to the following rules:

230VAC → 24VDC power supply → White LED io Receiver → LEDs + Remote control io

This controller has 4 outputs - so you can connect 2 strips separately to 2

inputs **230VAC → Outdoor Lighting RTS Receiver → 24VDC power supply →**

LEDs + RTS remote control 230VAC → 24VDC power supply → MiLight →

LEDs + MiLight remote control

230VAC → switch → 24VDC power supply → LEDs

Environmental conditions with increased risk:

Hazardous environments include bathrooms and showers, kitchens, garages, cellars, saunas, pet rooms, hospital operating theatres, hydrothermal pumps, heat exchangers, spaces enclosed by conductive surfaces, camping sites, open areas, etc. In rooms and spaces where there are conditions of increased risk, automatic devices should be used to switch off the power supply to the faulty product, e.g. residual current circuit breakers. It is recommended to use in bathrooms, kitchens, garages and cellars. It is compulsory to use around swimming and shower pools, saunas, on construction sites, when supplying power to outdoor equipment, on agricultural and horticultural farms, in camping and leisure vehicles and in rooms at risk of fire.

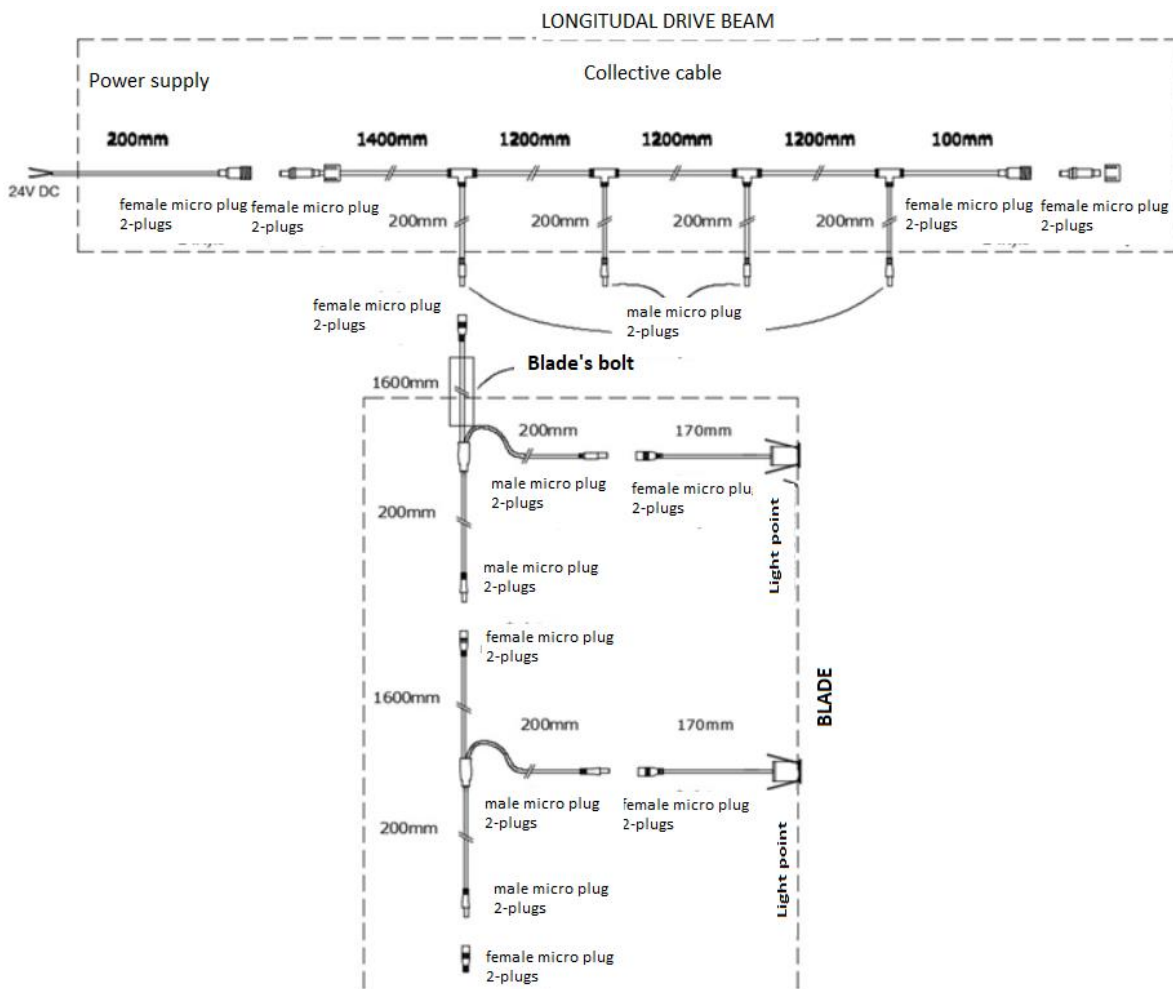

Cable connection diagram for light points

(Note: in the SB400PRO pergola the collector cable is laid in the longitudinal bearing beam)

4.7.2 COMMISSIONING AND ADJUSTMENT

- Before the lighting of the product is put into operation, the electrical measurements required by law must be taken.



Incorrect connection of power and control components can damage them or create a hazard.



The power supply is designed for a maximum operating temperature of +45°C and a maximum temperature of its case +90°C.

5 SYSTEM OPERATION AND PRODUCT SAFETY



The product may only be used if there are no defects.

5.1 GENERAL HEALTH AND SAFETY REQUIREMENTS

- In order to ensure the proper functioning of the product, SELT Sp. z o.o. forbids any structural changes, failure to comply with the above condition relieves the manufacturer of any responsibility for the product, any damage or loss and the customer loses any warranty or guarantee rights on it.
- During transport, assembly and disassembly, as well as during handling, care and maintenance of the product, the relevant health and safety and environmental regulations must be observed.
- The product should only be maintained and repaired by authorised and qualified (trained) persons.
- Persons entrusted with the day-to-day use, hygiene and maintenance of the product are obliged to read and observe the operating instructions in their entirety.
- It is not permissible to clean the product in any way other than that described under "Inspection, maintenance and repair".
- The electrical and control installation should be carried out and inspected by an authorised person.
- Maintenance work and product repair should only be carried out when the product is disconnected from the electricity supply.
- Care must be taken to ensure that the markings are not covered by a layer of paint or damaged in such a way that they cannot be read.
- It is recommended that any modification of the electrical design or change in the configuration of the fixtures should be consulted with SELT Ltd.
- The switch should be mounted at a height that complies with national regulations for people with disabilities, preferably at a height of less than 130 cm.
- Heat sources such as barbecues, open fires must not be located under the pergola.



5.2 SAFETY REQUIREMENTS RELATED TO SPECIFIC CONDITIONS AND LOCATIONS USE OF THE PRODUCT.

The specific safety requirements apply to children up to the age of 42 months. The special use requirements apply in all places where young children have access to or are likely to be present, such as, for example, homes, children's homes, hospitals, churches, shops, schools, nurseries, public places and other places where children may be present. In the event of a change of use to one of the above, the above comments should be implemented.

The special use requirements also apply in all areas where people with disabilities are present.



Before using the product, it is up to the Purchaser to carry out an individual risk assessment of its use with particular regard to the safety of children and people with disabilities.

When determining the performance requirements of a product, it is important to consider reasonably foreseeable conditions of use and potential hazards.



Do not allow children to play with the roof controls. Keep the remote control device away from children.



Inspect the installation frequently for signs of wear or damage to the cables. Do not use if repair is necessary.



Avoid contact of the product with hot objects (e.g. heaters, cookers, irons, chimneys, etc.) or placing sources of convective heat (e.g. cookers, cookers, barbecues, etc.) under the mobile roof, as this may lead to damage.

5.3 OPERATING SAFETY

Recommendations and actions:

- the product is safe to use provided that the instructions in the documentation are followed and that it is installed correctly,
- use the product only for its intended purpose,
- It is forbidden to use a product which does not comply with shock and fire safety requirements,
- keep remote control devices out of the reach of children, they are not a toy,
- It is forbidden to use a technically faulty product or to carry out makeshift repairs,
- it is forbidden to exceed the specified product operating parameters set out in the technical and user documentation,
- it is forbidden to use a faulty or incomplete product (e.g. without a switch etc.), use of such a product may cause damage to the product, endanger the health and life of the user and may invalidate the guarantee,
- use only original spare parts,
- all work relating to the inspection and repair of the product should be carried out by a suitably trained person with the required authorisations and qualifications,
- it is forbidden to use the product and the electrical installation without valid and required inspections and measurements,
- it is essential to disconnect the product from the electrical system before carrying out any maintenance or cleaning work,
- look out for any signs of wear or damage to electrical cables,
- if you notice signs of wear or damage to the electrical cables, disconnect the product from the power supply and have the fault rectified by an authorised person,
- if you use sharp objects, do not damage the paintwork,
- check that the electrical connections are in good condition and that the power cables are not tangled,
- when cleaning the product take special care because of moving parts and possibility of injury; disconnect the power supply, mark and secure the work area properly; before cleaning of the product remove loose dirt with a Hoover with a soft brush or broom and then clean with water and mild detergents using a soft cotton cloth; after cleaning always rinse the surface of the blades with water (use cleaning agents in accordance with the manufacturer's instructions); it is forbidden to use abrasive agents or pressure washers which may damage the lacquer coating,

In the event of any malfunction of the product, immediately notify the relevant SELT service centre. Using a defective product and attempting to repair it yourself poses a danger to health and life and may result in the loss of warranty rights, among other things.

5.4 CONTROL

Programming of the control (assignment of remote controls, weather sensors and other controls) should be done in accordance with the control manufacturer's instructions.

Programming instructions, depending on the control system used, are available on the manufacturers' websites and on the website:

www.selt.com → OUR OFFER → AUTOMATION



The receiver or control unit must be installed in a place where it will not be exposed to the weather and rain and will be inaccessible to children. SELT recommends mounting inside the pole or, if outside, in a sealed IP65 installation box. or in a flexible waterproof sheath with a minimum protection level of IP65.

Lighting controller		
Pilot	Receiver	
SOMFY	RTS (434 MHz)	IO (868 MHz)
Situo 5 RTS	Outdoor Lightnig Receiver RTS or LightningSilm Receiver RTS	
Situo 5 io Pure		White LED Receiver io
Mi Light		
MiLight remote control	Mi-Light FUT036	



In the event of a power failure, the lighting system with the Mi-Light controller will be in a switched-on state as standard when the power returns.

5.5 COMMISSIONING AND ADJUSTMENT

- before commissioning the product, electrical measurements must be carried out, primarily to check the effectiveness of the neutralisation of the product and the electrical installation by a qualified person,

5.6 MISUSE OF THE SYSTEM

Operation of the system - prohibited activities

- Use of the product in the event of a defect or suspected defect; it is recommended that further use of the product be discontinued.
- Report the fault to the supplier / system fitter / installer.
- Discontinue use of the product if there are signs of wear or damage to the electrical wiring and report concerns immediately to the direct supplier.
- Do not use a faulty or decomposed system. Use of such a product may damage it and create a risk to the health and life of the user and may void the warranty.
- It is forbidden to use a product that does not comply with shock and fire safety requirements.

- It is forbidden to exceed the product operating parameters specified in the technical and operating documentation.
- Do not keep any sharp objects or protruding parts near the system, which may snag and scratch it.

Persons assigned to handle

- Do not allow children to play with the components used to operate the system, e.g. the remote control or the switch.
- Keep the remote control away from children.

Automatically controlled products may start up automatically. When carrying out any work on the product, permanently immobilise the product so that it does not start accidentally. Make sure that no dangerous situation arises.

6 USE AND MAINTENANCE OF THE SYSTEM

6.1 USE OF THE SYSTEM FOR ITS INTENDED PURPOSE

The system must be used in accordance with its intended use as specified by the manufacturer. If the system is operated and modified in a manner other than that described in this documentation, the system manufacturer has grounds to disallow warranty or guarantee claims.

If the product is used in a manner other than that described in this documentation or is modified without the authorisation of SELT Sp. z o.o. then it is used incorrectly.

Making unauthorised changes affecting the safe operation of the product is not permitted. Proper use of the

product includes:

- normal use or foreseeable use, which does not include, for example, risks taken by the user intentionally or knowingly,
- application of permissible operating values,
- compliance with operating recommendations,
- carrying out periodic product inspection and maintenance,
- comply with the requirements set out in this Documentation,
- to comply with the requirements under "Technical specifications".

In case of misuse:



- the product may endanger operators,
- the product will be exposed to damage,
- This may have a negative impact on its functionality,
- not to use the system during maintenance or repair work, or in other cases as indicated by the manufacturer.

SELT Sp. z o.o. is not responsible for damage caused by improper use.

6.2 INSTRUCTIONS FOR NON-EXPERTS

Non-professionals are those who carry out activities related to the day-to-day use and ongoing maintenance of the product.

Before using the product, read this documentation carefully. Thorough knowledge of the

documentation allows for fault-free and safe operation of the product.

List of activities that can be performed by non-experts:

- day-to-day use of the product via a traditional switch or remote control,
- ongoing inspection of the product by switching the lighting on and off,
- have the product serviced, repaired and cleaned by a specialised installer.

6.3 INDICATIONS OF RISK, ACCIDENT OR INCIDENT

Description of residual risk

Risk factor	Description of correct procedure
Accident	- disconnect the product from the power supply, - take first aid measures on casualties - call for help tel. 112
Product failure (hazard)	- disconnect the product from the power supply, - remove users from the danger zone, - In the event of fire, use only ABC-class fire extinguishers, - notify the fire brigade if necessary, - notify the service company - if the failure only results in the blocking of the product without additional hazards - check point "Product failure (blockage)".

Electrocution,	The electrical installation must be carried out in accordance with the standards that apply in your country. - electrical conductors with double insulation and additional protection to protect the conductors mechanically and against UV radiation - residual current protection
Short circuit in the installation and fire	- conductors with the appropriate cross-section for the power of the consumers and for the selected overcurrent protection - overcurrent fuse according to the power of the consumers

6.4. TECHNICAL INSPECTIONS AND REPAIRS

Ongoing inspections

This is carried out by the customer himself. SELT recommends that servicing is carried out at the times stated below.

Basic activities comprising the current review:

- Visual inspection and ongoing removal of phytosanitary contamination (as soon as noticed),
- If a fault is observed, disconnect the product from the power supply and have it repaired immediately,
- Disconnect the product from the power supply (in particular in such a way as to prevent the product from being started up by the automation system) prior to servicing the product's moving and electrical components,
- If the product is placed at a height of more than 2.5 m, it is advisable for a specialised team to carry out the above work.

Technical inspections

This is carried out by SELT or a specialised installer on commission after the warranty period has expired. The scope is defined in each case by the specialised installation team and the execution is confirmed by a service protocol.

Cleaning



It is essential to disconnect the product from the power supply before cleaning.

Cleaning of metal / aluminium components:

- It is recommended to clean light dirt on accessible metal / aluminium surfaces with water and mild detergents, using a soft cotton cloth, always rinse after cleaning (if necessary).
- Remove phytosanitary contamination (as soon as it is noticed).

Prohibited activities when cleaning the product:

- The use of pressure washers, as well as cleaning agents, sponges and solvents (e.g. alcohol, petrol) is prohibited.
- It is forbidden to use cleaning agents with chlorine, ammonia, paraffin, acetone and bleach to clean the system as well as in its vicinity, as this will result in the risk of corrosion.
- The use of sharp tools (e.g. wire brushes), cleaning agents that cause scratches (e.g. scouring powders, pastes) is prohibited.
- Do not firmly hold or pull the system or its individual components.
- Do not replace damaged components with replacements! Use original spare parts!
- After cleaning, connect the power supply (control) and test the operation of the system. Keep an eye on the operation of the system and if unusual behaviour and noises occur, report the problem to the direct supplier.

Repairs

Any abnormal/abnormal operation of the system or abnormal noises from its operation require the user's intervention and a report to a specialised installer. Repairs are carried out by SELT Sp. z o.o. or a specialised installation team on the basis of a separate agreement.

7 COMPLAINTS/TECHNICAL DEFECTS

7.1 COMPLAINTS (MANUFACTURER'S WARRANTY)

A claim for a product can only be made by the entity that purchased the product from the manufacturer. The conditions and the manner of handling complaints are specified in the General Terms of Guarantee and General Terms of Sale. The General Guarantee Terms and Conditions and the General Terms and Conditions of Sale are available on the website: selt.com

The Customer shall submit a complaint on the Complaint Form available on the manufacturer's B2B Platform. The complaint notification should be complete and full.

A claim submitted otherwise than via the B2B Platform, incomplete or incomplete, including without an invoice, order or contract number, will not be processed.

7.2 TECHNICAL DEFECTS

In the event of system defects, you should:

- if possible, take the device out of service,
- immediately report the defect of the product to the competent specialized assembly team.

8 DISMANTLING / DISPOSAL / DECOMMISSIONING OF THE PRODUCT



Improper dismantling of the system can cause serious injury and damage to the system.

The dismantling of the system should be carried out by a suitably specialised installation team or a person with appropriate health and safety training and recovery expertise.

a) Disposal of waste electrical and electronic equipment

At the end of the life of the product, it is necessary to dismantle it and segregate the individual materials and components in accordance with the Decree of the Minister of Climate of 2 January 2020 on the waste catalogue in order to dispose of it.

Important information on disposal:

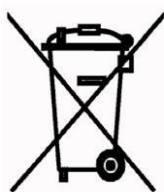

According to the provisions of the Act of 11 September 2015 on waste electrical or electronic equipment, it is prohibited to place together with other waste used equipment marked with the symbol of a crossed-out municipal waste container. A user wishing to dispose of electronic or electrical equipment is obliged to take it to a waste equipment collection point.

These statutory obligations have been introduced in order to limit the amount of waste produced from waste electrical and electronic equipment and to ensure an appropriate level of collection, recovery and recycling. The equipment does not contain hazardous components that have a particularly negative impact on the environment and human health.

Lp.	Subject	European legal basis	Polish Legal Basis
1	Waste electrical equipment and electronic	Directive 2012/19 EU of the European Parliament and of the Council of 4 July 2012 on waste electrical and electronic equipment (WEEE)	Act of 11 September 2015 on waste electrical and electronic equipment (Journal of Laws 2020, item 1893, as amended).
2	Waste catalogue	Commission Regulation (EC) No 574/2004 of 23 February 2004 amending Annexes I and III to Regulation (EC) No 2150/2002 of the Parliament of the European Parliament and of the Council on waste statistics	Regulation of the Minister of Climate of 2 January 2020 on the waste catalogue (Journal of Laws 2020, item 10)

b) Disposal of used batteries

In accordance with the provisions of the Batteries and Accumulators Act of 24 April 2009, the **end user** is obliged to hand over used portable batteries that are no longer a source of energy to a waste battery **collector** or collection point. It is prohibited to place used batteries together with other waste in the same container.

In order to prevent contamination of the environment and the possible risk to human and animal health, the used battery should be disposed of in a suitable container at designated collection points.

Lp.	Subject	European legal basis	Polish Legal Basis
1	Waste batteries and accumulators	Directive 2006/66/EC of the European Parliament and of the Council of 6 September 2006 on batteries and accumulators and waste batteries and accumulators and repealing Directive 91 / 157 / EEC	Act of 24 April 2009 on batteries and accumulators (consolidated text Dz. U. of 2020, item 1850)

9 CE LABELLING AND MARKING OF THE PRODUCT**9.1 CONFORMITY OF THE PRODUCT WITH THE CE STANDARD**

The lighting set meets the essential requirements of the directives and product standards set out for the power supply, driver and LED strip, as confirmed by the Manufacturers' declarations of conformity for the power supply, driver and LED strip.

IN ORDER TO MAINTAIN THIS CONDITION AND TO ENSURE SAFE OPERATION AND MAINTENANCE OF THE SYSTEM, THE INSTALLATION INSTRUCTIONS AND INSTRUCTIONS FOR SAFE USE MUST BE FOLLOWED.

10 EXCLUSIONS FROM LIABILITY

The General Terms and Conditions of Guarantee are available at www.selt.com. If you do not have access to the SELT Sp. z o.o. website, the warranty conditions can be obtained from your SELT Sp. z o.o. sales representative.

10.1 EXCLUSIONS FROM LIABILITY

SELT Sp. z o.o. is not liable and does not discharge any warranty or guarantee in the event of:

- Damage caused by transport other than SELT.
- Damage caused by storage, installation, use of the product and maintenance not in accordance with the technical and operating documents, the instructions for use or the manufacturer's recommendations, unless these activities were carried out by the manufacturer.
- Damage resulting from the alteration of the system, unless the alteration was carried out by the manufacturer, on his instructions or with his written consent.
- Secondary damage resulting from the use of the appliance despite the original defect being noticed, unless the manufacturer has been informed and has recommended further use. The assessment of the causes of the damage is left to the reasonable discretion of the manufacturer. Repair or replacement of the device due to the damage referred to in this section may be carried out by the manufacturer against payment.
- Defects due to age and normal wear and tear of product parts.
- Mechanical and electrical damage caused by the user.
- Damage caused by incorrect installation of the product, carried out by a company other than the manufacturer.
- Damage caused by spontaneous repair.
- Damage caused by use of the system in inappropriate weather conditions (outside the scope of the instructions).
- Damage caused by abnormal weather conditions (lightning, storm, hail, water, fire).
- Damage resulting from accidents and unexpected events.
- Damage resulting from inadequate cleaning with unsuitable tools, corrosive or abrasive substances.
- Atmospheric and phytosanitary contamination and fouling caused by animals.
- Soiling of the paintwork in urban environments exposed to pollution (smog, smoke, acid rain, dust).
- Damage caused by the influence of other products, objects or suspended accessories not foreseen by SELT.
- Deformation and damage to the structure, in particular the blades, caused by the load exerted by the user (standing, moving or hanging on the product).
- Colour variations in parts that may occur during the production process.
- Discolouration of components intensively exposed to the weather.
- Corrosion of components operated in an environment with high sea salt content in the air.
- Damage caused by commissioning in frost conditions and other natural factors.
- Damage resulting from thermal cracking of the LED point lens when sudden climatic factors (rain, snow) act on the heated housing and the point lens.

Selt is also not responsible for:

- A product in which the CE sticker has been removed or is illegible,
- A product in which the pictograms indicating particularly important hazard and safety information have been removed,
- Misuse of the product or not in accordance with its intended use,
- Damage caused by fluctuations in the mains voltage if they exceed 5% or by faulty control,
- To prevent overheating of the product, heat sources such as grills, open fires must not be located within the system,
- SELT Sp. z o.o. is also not liable for any incidents resulting from non-compliance with this documentation or for the consequences of incidents which the installer, investor or specialised installation team should have taken into account when carrying out the investment or work.

Notwithstanding the above, the scope of responsibility of SELT Sp. z o.o. is limited and results from the contract concluded with the purchaser of the product.